

STANLEY®

SD67 HYDRAULIC SPIKE DRIVER



USER MANUAL Safety, Operation and Maintenance



© 2014 STANLEY Black & Decker, Inc.
New Britain, CT 06053
U.S.A.
17488 8/2017 Ver. 14

TABLE OF CONTENTS

SAFETY SYMBOLS.....	4
SAFETY PRECAUTIONS	5
TOOL STICKERS & TAGS	6
HOSE TYPES	7
HOSE RECOMMENDATIONS.....	8
HTMA / EHTMA REQUIREMENTS	9
OPERATION	10
TOOL PROTECTION & CARE.....	11
TROUBLESHOOTING	12
CHARGING THE ACCUMULATOR.....	13
SPECIFICATIONS	14
SD67 PARTS ILLUSTRATION	15
SD67 PARTS LIST	16

IMPORTANT

To fill out a product warranty validation form, and for information on your warranty, visit www.stanleyinfrastructure.com and select the Company tab > Warranty.

Note: The warranty validation record must be submitted to validate the warranty.

SERVICING: This manual contains safety, operation and routine maintenance instructions. STANLEY Infrastructure recommends that servicing of hydraulic tools, other than routine maintenance, must be performed by an authorized and certified dealer. Please read the following warning.

⚠ WARNING







SERIOUS INJURY OR DEATH COULD RESULT FROM THE IMPROPER REPAIR OR SERVICE OF THIS TOOL.

REPAIRS AND / OR SERVICE TO THIS TOOL MUST ONLY BE DONE BY AN AUTHORIZED AND CERTIFIED DEALER.

For the nearest certified dealer, call STANLEY Infrastructure at (503) 659-5660 and ask for a Customer Service Representative.

SAFETY SYMBOLS

Safety symbols and signal words, as shown below, are used to emphasize all operator, maintenance and repair actions which, if not strictly followed, could result in a life-threatening situation, bodily injury or damage to equipment.

	<p>This is the safety alert symbol. It is used to alert you to potential personal injury hazards. Obey all safety messages that follow this symbol to avoid possible injury or death.</p>
	<p>This safety alert and signal word indicates an imminently hazardous situation which, if not avoided, <u>will</u> result in <u>death or serious injury</u>.</p>
	<p>This safety alert and signal word indicates a potentially hazardous situation which, if not avoided, <u>could</u> result in <u>death or serious injury</u>.</p>
	<p>This safety alert and signal word indicates a potentially hazardous situation which, if not avoided, <u>could</u> result in <u>death or serious injury</u>.</p>
	<p>This signal word indicates a potentially hazardous situation which, if not avoided, <u>may</u> result in <u>property damage</u>.</p>
	<p>This signal word indicates a situation which, if not avoided, <u>will</u> result in <u>damage to the equipment</u>.</p>
	<p>This signal word indicates a situation which, if not avoided, <u>may</u> result in <u>damage to the equipment</u>.</p>

Always observe safety symbols. They are included for your safety and for the protection of the tool.

LOCAL SAFETY REGULATIONS

Enter any local safety regulations here. Keep these instructions in an area accessible to the operator and maintenance personnel.

SAFETY PRECAUTIONS

Tool operators and maintenance personnel must always comply with the safety precautions given in this manual and on the stickers and tags attached to the tool and hose.

These safety precautions are given for your safety. Review them carefully before operating the tool and before performing general maintenance or repairs.

Supervising personnel should develop additional precautions relating to the specific work area and local safety regulations. If so, place the added precautions in the space provided in this manual.

The SD67 Hydraulic Spike Driver will provide safe and dependable service if operated in accordance with the instructions given in this manual. Read and understand this manual and any stickers and tags attached to the tool and hoses before operation. Failure to do so could result in personal injury or equipment damage.



- Operator must start in a work area without bystanders. The operator must be familiar with all prohibited work areas such as excessive slopes and dangerous terrain conditions.
- Establish a training program for all operators to ensure safe operation.
- Do not operate the tool unless thoroughly trained or under the supervision of an instructor.
- Always wear safety equipment such as goggles, ear and head protection and safety shoes at all times when operating the tool.
- Do not inspect or clean the tool while the hydraulic power source is connected. Accidental engagement of the tool can cause serious injury.
- Always connect hoses to the tool hose couplers before energizing the hydraulic power source. Be sure all hose connections are tight.
- Do not operate the tool at oil temperatures above 140 °F/60 °C. Operation at higher temperatures can cause higher than normal temperatures at the tool which can result in operator discomfort.
- Do not operate a damaged, improperly adjusted or incompletely assembled spike driver.
- Do not weld, cut with an acetylene torch or hardface the spike driver ram or foot.

- To avoid personal injury or equipment damage, all tool repair, maintenance and service must only be performed by authorized and properly trained personnel.

- **WARNING:** Some dust created by power sanding, sawing, grinding, drilling, and other construction activities contains chemicals known to the State of California to cause cancer, birth defects or other reproductive harm. Some examples of these chemicals are:

- Lead from lead-based paints,
- crystalline silica from bricks and cement and other masonry products, and
- arsenic and chromium from chemically-treated lumber.

Your risk from these exposures varies, depending on how often you do this type of work. To reduce your exposure to these chemicals: work in a well ventilated area, and work with approved safety equipment, such as those dust masks that are specially designed to filter out microscopic particles.

Protect yourself and those around you. Research and understand the materials you are cutting. Follow correct safety procedures and comply with all applicable national, state or provisional health and safety regulations relating to them, including, if appropriate arranging for the safe disposal of the materials by a qualified person.

TOOL STICKERS & TAGS

STANLEY
3810 SE Naef Road
Milwaukie, OR 97267 USA

74659

SD67 SPIKE DRIVER

WEIGHT: 55 lb/25kg
FLOW: 4–6gpm/15–23lpm
MAX PRESS: 2500psi/172bar
NOM PRESS: 1500psi/103bar
ACCUMULATOR CHARGE:
600psi/41bar NITROGEN

These numbers pictured are for example only and may not relate to your model of spike driver, see decal part number for below.

STANLEY RAILROAD HELP DESK
1–800–549–0517
FOR CUSTOMER SERVICE OR
TECHNICAL QUESTIONS

73680
Railroad Help Desk Sticker

74670
SD67 Name Tag

STANLEY®

74832
Stanley Logo

NOTE:
THE INFORMATION LISTED ON THE STICKERS SHOWN, MUST BE LEGIBLE AT ALL TIMES.
REPLACE DECALS IF THEY BECOME WORN OR DAMAGED. REPLACEMENTS ARE AVAILABLE FROM YOUR LOCAL STANLEY DISTRIBUTOR.

The safety tag (P/N 15875) at right is attached to the tool when shipped from the factory. Read and understand the safety instructions listed on this tag before removal. We suggest you retain this tag and attach it to the tool when not in use.

D A N G E R

- FAILURE TO USE HYDRAULIC HOSE LABELED AND CERTIFIED AS NON-CONDUCTIVE WHEN USING HYDRAULIC TOOLS ON OR NEAR ELECTRICAL LINES MAY RESULT IN DEATH OR SERIOUS INJURY.
BEFORE USING HOSE LABELED AND CERTIFIED AS NON-CONDUCTIVE ON OR NEAR ELECTRICAL LINES BE SURE THE HOSE IS MAINTAINED AS NON-CONDUCTIVE. THE HOSE SHOULD BE REGULARLY TESTED FOR ELECTRIC CURRENT LEAKAGE IN ACCORDANCE WITH YOUR SAFETY DEPARTMENT INSTRUCTIONS.
- A HYDRAULIC LEAK OR BURST MAY CAUSE OIL INJECTION INTO THE BODY OR CAUSE OTHER SEVERE PERSONAL INJURY.
 - DO NOT** EXCEED SPECIFIED FLOW AND PRESSURE FOR THIS TOOL. EXCESS FLOW OR PRESSURE MAY CAUSE A LEAK OR BURST.
 - DO NOT** EXCEED RATED WORKING PRESSURE OF HYDRAULIC HOSE USED WITH THIS TOOL. EXCESS PRESSURE MAY CAUSE A LEAK OR BURST.
 - CHECK TOOL HOSE COUPLERS AND CONNECTORS DAILY FOR LEAKS. **DO NOT** FEEL FOR LEAKS WITH YOUR HANDS. CONTACT WITH A LEAK MAY RESULT IN SEVERE PERSONAL INJURY.

I M P O R T A N T

READ OPERATION MANUAL AND SAFETY INSTRUCTIONS FOR THIS TOOL BEFORE USING IT.

USE ONLY PARTS AND REPAIR PROCEDURES APPROVED BY STANLEY AND DESCRIBED IN THE OPERATION MANUAL.

TAG TO BE REMOVED ONLY BY TOOL OPERATOR.

SEE OTHER SIDE

D A N G E R

- DO NOT LIFT OR CARRY TOOL BY THE HOSES. DO NOT ABUSE HOSE. DO NOT USE KINKED, TORN OR DAMAGED HOSE.
- MAKE SURE HYDRAULIC HOSES ARE PROPERLY CONNECTED TO THE TOOL BEFORE PRESSURING SYSTEM. SYSTEM PRESSURE HOSE MUST ALWAYS BE CONNECTED TO TOOL "IN" PORT. SYSTEM RETURN HOSE MUST ALWAYS BE CONNECTED TO TOOL "OUT" PORT. REVERSING CONNECTIONS MAY CAUSE REVERSE TOOL OPERATION WHICH CAN RESULT IN SEVERE PERSONAL INJURY.
- DO NOT CONNECT OPEN-CENTER TOOLS TO CLOSED-CENTER HYDRAULIC SYSTEMS. THIS MAY RESULT IN LOSS OF OTHER HYDRAULIC FUNCTIONS POWERED BY THE SAME SYSTEM AND/OR SEVERE PERSONAL INJURY.
- BYSTANDERS MAY BE INJURED IN YOUR WORK AREA. KEEP BYSTANDERS CLEAR OF YOUR WORK AREA.
- WEAR HEARING, EYE, FOOT, HAND AND HEAD PROTECTION.
- TO AVOID PERSONAL INJURY OR EQUIPMENT DAMAGE, ALL TOOL REPAIR MAINTENANCE AND SERVICE MUST ONLY BE PERFORMED BY AUTHORIZED AND PROPERLY TRAINED PERSONNEL.

I M P O R T A N T

READ OPERATION MANUAL AND SAFETY INSTRUCTIONS FOR THIS TOOL BEFORE USING IT.

USE ONLY PARTS AND REPAIR PROCEDURES APPROVED BY STANLEY AND DESCRIBED IN THE OPERATION MANUAL.

TAG TO BE REMOVED ONLY BY TOOL OPERATOR.

SEE OTHER SIDE

SAFETY TAG P/N 15875 (Shown smaller than actual size)

HOSE TYPES

The rated working pressure of the hydraulic hose must be equal to or higher than the relief valve setting on the hydraulic system. There are three types of hydraulic hose that meet this requirement and are authorized for use with STANLEY hydraulic tools. They are:

Certified non-conductive — constructed of thermoplastic or synthetic rubber inner tube, synthetic fiber braid reinforcement, and weather resistant thermoplastic or synthetic rubber cover. *Hose labeled **certified non-conductive** is the only hose authorized for use near electrical conductors.*

Wire-braided (conductive) — constructed of synthetic rubber inner tube, single or double wire braid reinforcement, and weather resistant synthetic rubber cover. *This hose is **conductive** and must never be used near electrical conductors.*

Fabric-braided (not certified or labeled non-conductive) — constructed of thermoplastic or synthetic rubber inner tube, synthetic fiber braid reinforcement, and weather resistant thermoplastic or synthetic rubber cover. *This hose is **not certified non-conductive** and must never be used near electrical conductors.*

HOSE SAFETY TAGS

To help ensure your safety, the following DANGER tags are attached to all hose purchased from STANLEY. DO NOT REMOVE THESE TAGS.

If the information on a tag is illegible because of wear or damage, replace the tag immediately. A new tag may be obtained from your STANLEY Distributor.

THE TAG SHOWN BELOW IS ATTACHED TO “CERTIFIED NON-CONDUCTIVE” HOSE

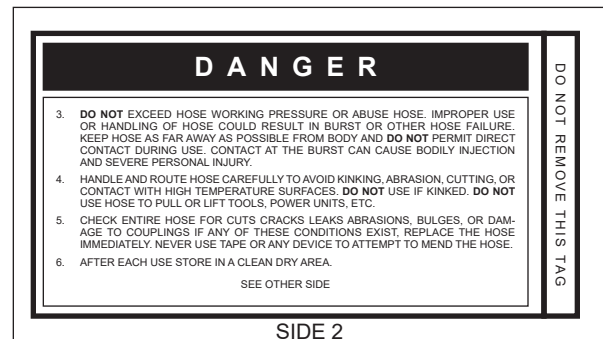
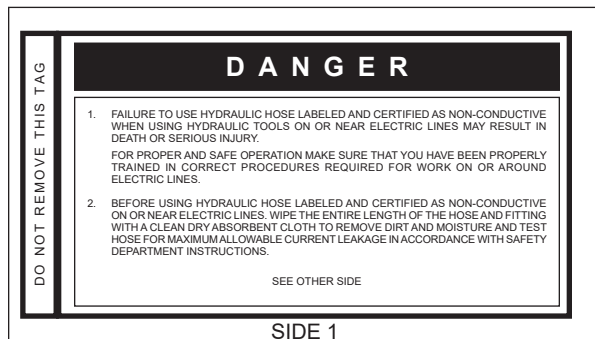

(Shown smaller than actual size)

THE TAG SHOWN BELOW IS ATTACHED TO “CONDUCTIVE” HOSE.

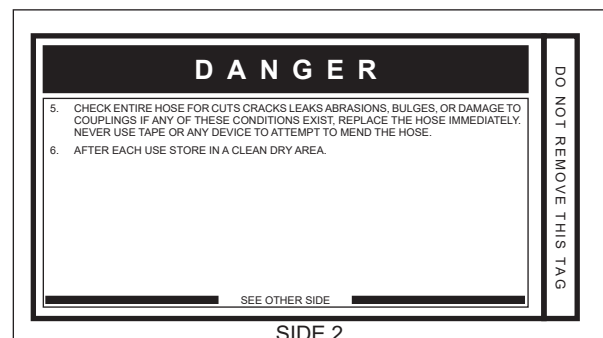
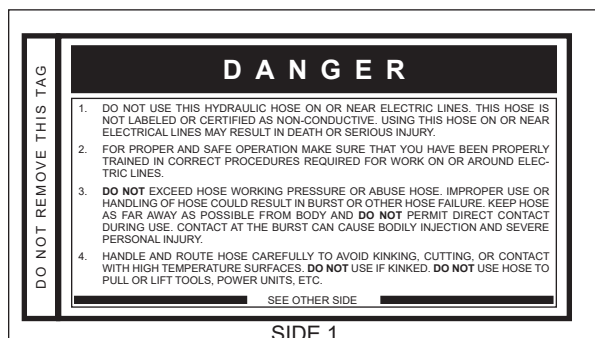

(Shown smaller than actual size)

HOSE RECOMMENDATIONS

Tool to Hydraulic Circuit Hose Recommendations

The chart to the right shows recommended minimum hose diameters for various hose lengths based on gallons per minute (GPM)/liters per minute (LPM). These recommendations are intended to keep return line pressure (back pressure) to a minimum acceptable level to ensure maximum tool performance.

This chart is intended to be used for hydraulic tool applications only based on STANLEY tool operating requirements and should not be used for any other applications.

All hydraulic hose must have at least a rated minimum working pressure equal to the maximum hydraulic system relief valve setting.

All hydraulic hose must meet or exceed specifications as set forth by SAE J517.

Oil Flow		Hose Lengths		Inside Diameter		USE (Press/Return)	Min. Working Pressure	
GPM	LPM	FEET	METERS	INCH	MM		PSI	BAR
Certified Non-Conductive Hose - Fiber Braid - for Utility Bucket Trucks								
4-9	15-34	up to 10	up to 3	3/8	10	Both	2250	155
Conductive Hose - Wire Braid or Fiber Braid - DO NOT USE NEAR ELECTRICAL CONDUCTORS								
4-6	15-23	up to 25	up to 7.5	3/8	10	Both	2500	175
4-6	15-23	26-100	7.5-30	1/2	13	Both	2500	175
5-10.5	19-40	up to 50	up to 15	1/2	13	Both	2500	175
5-10.5	19-40	51-100	15-30	5/8	16	Both	2500	175
5-10.5	19-40	100-300	30-90	5/8	16	Pressure	2500	175
10-13	38-49	up to 50	up to 15	3/4	19	Return	2500	175
10-13	38-49	51-100	15-30	5/8	16	Both	2500	175
10-13	38-49	100-200	30-60	3/4	19	Pressure	2500	175
13-16	49-60	up to 25	up to 8	1	25.4	Return	2500	175
13-16	49-60	26-100	8-30	5/8	16	Pressure	2500	175
13-16	49-60	26-100	8-30	3/4	19	Return	2500	175
13-16	49-60	26-100	8-30	3/4	19	Pressure	2500	175
13-16	49-60	26-100	8-30	1	25.4	Return	2500	175

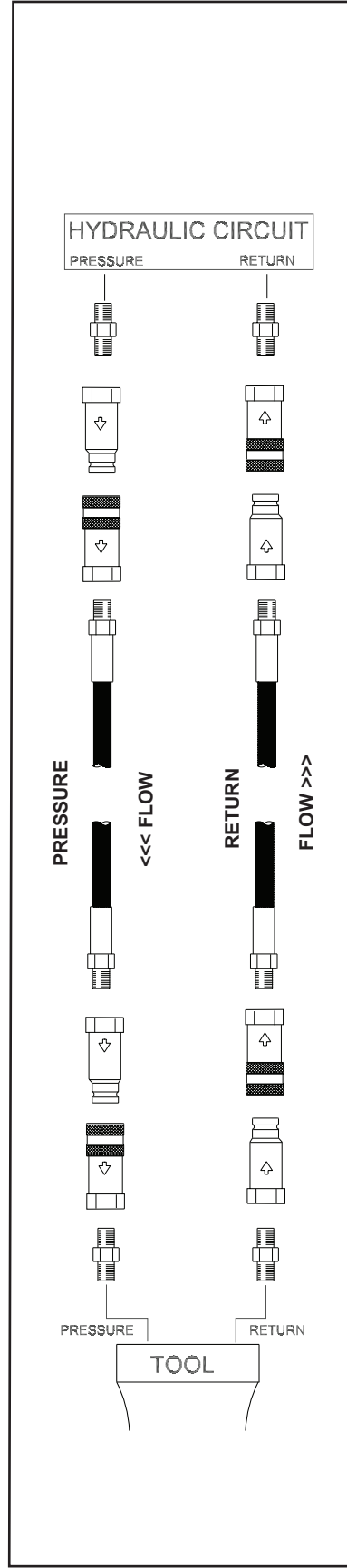

Figure 1. Typical Hose Connections





HTMA / EHTMA REQUIREMENTS

HTMA / EHTMA REQUIREMENTS

TOOL TYPE

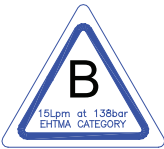
HTMA HYDRAULIC SYSTEM REQUIREMENTS	TYPE I	TYPE II	TYPE RR	TYPE III
Flow range	4-6 GPM (15-23 LPM)	7-9 GPM (26-34 LPM)	9-10.5 GPM (34-40 LPM)	11-13 GPM (42-49 LPM)
Nominal operating pressure (At the power supply outlet)	1500 psi (103 bar)	1500 psi (103 bar)	1500 psi (103 bar)	1500 psi (103 bar)
System relief valve setting (At the power supply outlet)	2100-2250 psi (145-155 bar)	2100-2250 psi (145-155 bar)	2200-2300 psi (152-159 bar)	2100-2250 psi (145-155 bar)
Maximum back pressure (At tool end of the return hose)	250 psi (17 bar)	250 psi (17 bar)	250 psi (17 bar)	250 psi (17 bar)
Measured at a max fluid viscosity of: (At minimum operating temperature)	400 ssu* (82 centistokes)	400 ssu* (82 centistokes)	400 ssu* (82 centistokes)	400 ssu* (82 centistokes)
Temperature: Sufficient heat rejection capacity to limit maximum fluid temperature to: (At maximum expected ambient temperature)	140° F (60° C)	140° F (60° C)	140° F (60° C)	140° F (60° C)
Minimum cooling capacity at a temperature difference of between ambient and fluid temps	3 hp (2.24 kW) 40° F (22° C)	5 hp (3.73 kW) 40° F (22° C)	6 hp (5.22 kW) 40° F (22° C)	7 hp (4.47 kW) 40° F (22° C)
Note: Do not operate the tool at oil temperatures above 140° F (60° C). Operation at higher temperatures can cause operator discomfort at the tool.				
Filter minimum full-flow filtration Sized for flow of at least: (For cold temp startup and maximum dirt-holding capacity)	25 microns 30 GPM (114 LPM)	25 microns 30 GPM (114 LPM)	25 microns 30 GPM (114 LPM)	25 microns 30 GPM (114 LPM)
Hydraulic fluid, petroleum based (premium grade, anti- wear, non-conductive) Viscosity (at minimum and maximum operating temps)	100-400 ssu (20-82 centistokes)	100-400 ssu (20-82 centistokes)	100-400 ssu (20-82 centistokes)	100-400 ssu (20-82 centistokes)
Note: When choosing hydraulic fluid, the expected oil temperature extremes that will be experienced in service determine the most suitable temperature viscosity characteristics. Hydraulic fluids with a viscosity index over 140 will meet the requirements over a wide range of operating temperatures.				
*SSU = Saybolt Seconds Universal				

CLASSIFICATION

EHTMA HYDRAULIC SYSTEM REQUIREMENTS					
Flow range	3.5-4.3 GPM (13.5-16.5 LPM)	4.7-5.8 GPM (18-22 LPM)	7.1-8.7 GPM (27-33 LPM)	9.5-11.6 GPM (36-44 LPM)	11.8-14.5 GPM (45-55 LPM)
Nominal operating pressure (At the power supply outlet)	1870 psi (129 bar)	1500 psi (103 bar)	1500 psi (103 bar)	1500 psi (103 bar)	1500 psi (103 bar)
System relief valve setting (At the power supply outlet)	2495 psi (172 bar)	2000 psi (138 bar)	2000 psi (138 bar)	2000 psi (138 bar)	2000 psi (138 bar)

Note: These are general hydraulic system requirements. See tool specification page for tool specific requirements.

OPERATION

PREPARATION PROCEDURES

PREPARATION FOR INITIAL USE

Each unit as shipped has no special unpacking or assembly requirements prior to usage. Inspection to assure the unit was not damaged in shipping and does not contain packing debris is all that is required.

CHECK HYDRAULIC POWER SOURCE

1. Using a calibrated flowmeter and pressure gauge, check that the hydraulic power source develops a flow of 7–10 gpm/26–38 lpm at 2000 psi/105–140 bar.
2. Make certain the hydraulic power source is equipped with a relief valve set to open at 2100–2250 psi/145–155 bar minimum.
3. Check that the hydraulic circuit matches the tool for open-center (OC) operation.

CHECK TOOL

1. Make sure all tool accessories are correctly installed. Failure to install tool accessories properly can result in damage to the tool or personal injury.
2. There should be no signs of leaks.
3. The tool should be clean, with all fittings and fasteners tight.

CHECK TRIGGER MECHANISM

1. Check that the trigger operates smoothly and is free to travel between the **ON** and **OFF** positions.

CONNECT HOSES

1. Wipe all hose couplers with a clean lint-free cloth before making connections.
2. Connect the hoses from the hydraulic power source to the hose couplers on the spike driver. Connect the return hose first and disconnect it last to minimize or avoid trapped pressure within the spike driver.
3. Observe flow indicators stamped on hose couplers to be sure that oil will flow in the proper direction. The female coupler is the inlet coupler.

NOTE: Uncoupled hoses left in the sun may be difficult to connect. When possible, connect the free ends of operating hoses together.

OPERATING PROCEDURES

1. Observe all safety precautions.
2. Move the hydraulic circuit control valve to the **ON** position.
3. Place the spike driver foot firmly on the spike to be driven.

4. Squeeze the trigger to start the spike driver. Adequate down pressure is very important. When the spike fully sets in the tie, release the trigger.

NOTE: Partially depressing the trigger allows the tool to operate at a slow speed, making it easy to start the spike in the tie.

COLD WEATHER OPERATION

If the spike driver is to be used during cold weather, preheat the hydraulic fluid at low engine speed. When using the normally recommended fluids, fluid temperature should be at or above 50 °F/10 °C (400 ssu/82 centistokes) before use.

TOOL PROTECTION & CARE

NOTICE

In addition to the safety precautions found in this manual, observe the following for equipment protection and care.

- Always store an idle tool in a clean dry space, safe from damage or pilferage.
- Do not exceed the rated limits or use the tool for applications beyond its design capacity.
- Always keep critical tool markings, such as labels and warning stickers, legible.
- Always replace hoses, couplings and other parts with replacement parts recommended by STANLEY. Supply hoses must have a minimum working pressure rating of 2500 psi/175 bar.
- Permit only experienced personnel to perform tool repair.
- Be sure to wipe all couplers clean before connecting. Use only lint-free cloths.
- The hydraulic circuit control valve must be in the **OFF** position when coupling or uncoupling the grinder. Failure to do so may result in damage to the quick couplers and cause overheating of the hydraulic system.
- Check fastener tightness often and before each use daily.

TROUBLESHOOTING

If symptoms of poor performance develop, the following chart can be used as a guide to correct the problem.

When diagnosing faults in operation of the spike driver, always check that the hydraulic power source is supplying the correct hydraulic flow and pressure to the spike driver as listed in the table. Use a flowmeter known to be accurate. Check the flow with the hydraulic oil temperature at least 80 °F/27 °C.

Problem	Cause	Solution
Spike driver does not run.	Power unit not functioning.	Check power unit for proper flow and pressure (7–10 gpm 26–38 lpm, 2000 psi 140 bar).
	Couplers or hoses blocked.	Remove restriction.
	Pressure and return line hoses reversed at ports.	Be sure hoses are connected to their proper ports.
	Mechanical failure of piston or automatic valve.	Have tool inspected and repaired by authorized dealer.
Spike driver does not hit effectively.	Power unit not functioning.	Check power unit for proper flow and pressure (7–10 gpm 26–38 lpm, 2000 psi 140 bar).
	Couplers or hose blocked.	Remove restriction.
	Low accumulator charge (pressure hose will pulse more than normal).	Have recharge by authorized dealer.
	Fluid too hot (above 140 °F/60 °C).	Provide cooler to maintain proper fluid temperature.
	Ram is not sliding freely in the spike driver foot.	Remove, clean and replace as required.
Spike driver operates slow.	Low oil flow from power unit.	Check power source for proper flow.
	High back pressure.	Check hydraulic system for excessive back pressure and correct as required.

CHARGING THE ACCUMULATOR

To check or charge the accumulator the following equipment is required:

- Accumulator tester (Part Number 02835).
 - Charging assembly (P/N 31254—includes a regulator, hose and fitting).
 - Nitrogen bottle with an 800 psi/56 bar minimum charge.
1. On charge valves containing 5/8 inch hex locking nuts, first loosen the locking nut 1-1/2 turns.
 2. Holding the chuck end of the STANLEY tester (P/N 02835), turn the gauge fully counterclockwise to ensure the stem inside the chuck is completely retracted.
 3. Thread the tester onto the charging valve of the tool accumulator (do not advance the gauge end into the chuck end. Turn as a unit). Seat the chuck on the accumulator charging valve and hand tighten only.
 4. Advance the valve stem by turning the gauge end clockwise.
 5. Connect the charging assembly to the valve on the tester.

6. Adjust the regulator on the nitrogen bottle to 600 psi/42 bar.

NOTE: It may be necessary to set the regulator at 650–700 psi/45–48 bar to overcome any pressure drop through the charging system.

7. Open the valve on the charging assembly hose. When the tester gauge reads 600–700 psi/42–48 bar, close the valve on the charging assembly hose and remove the charging valve.
8. Turn the gauge end of the tester fully counterclockwise to retract the plunger in the chuck. Remove the tester from the charger valve.
9. On charge valves containing 5/8 inch hex locking nuts, tighten the locking nut.

TESTING THE ACCUMULATOR

1. Follow Steps 1 through 4 in “Charging The Accumulator”.
2. Read the pressure on the gauge (pressure should be between 500–600 psi/35–42 bar).
3. If the pressure is low, recharge the tool.

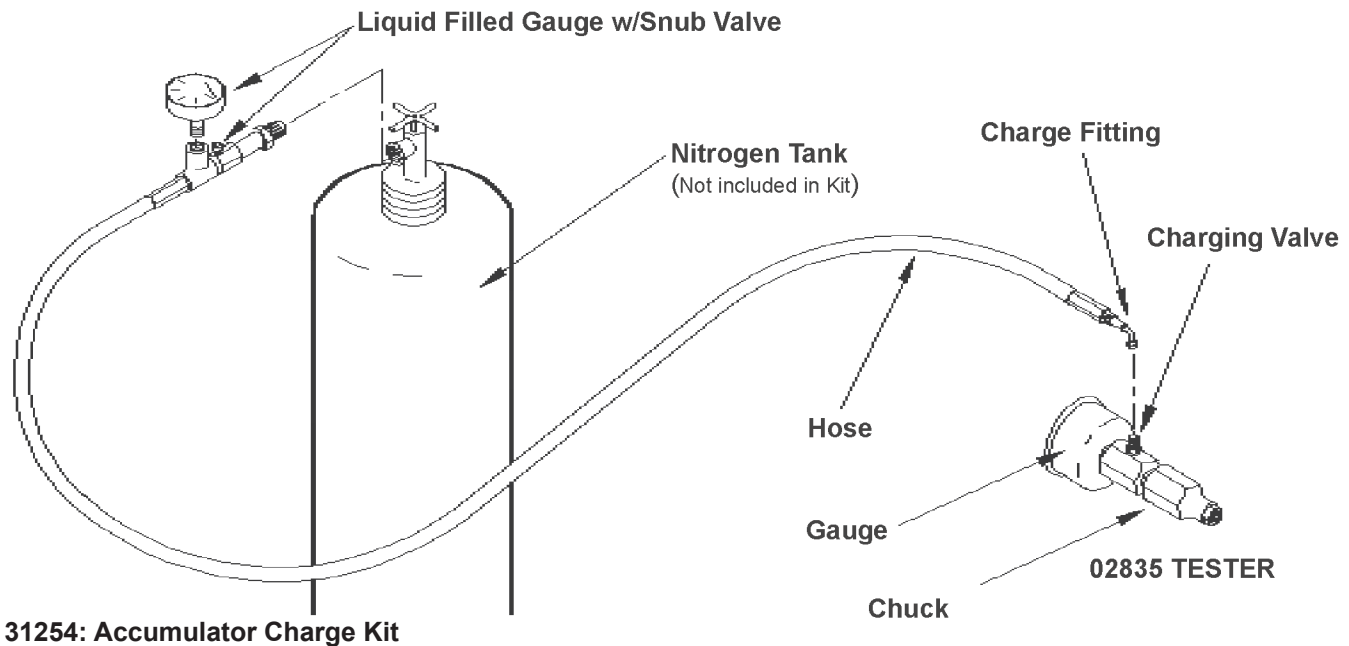

31254: Accumulator Charge Kit

Includes: Liquid filled gauge with Snub Valve, Hose, Charge fitting, 02835 Tester and Box (not pictured).

Figure 2. Charging the Accumulator

SPECIFICATIONS

Capacity (Spike Head).....	1.9 in dia/4.8 cm dia
Pressure Range Nominal	1500 psi/103 bar
Pressure Range Max.....	2500 psi/172 bar
Blows Per Minute.....	1300 to 1800
Maximum Back Pressure.....	250 psi/17 bar
Flow Range	7–10 gpm/26–38 lpm
Porting	-8 SAE O-ring
Couplers	HTMA/EHTMA Flush Face Type Male & Female
Connect Size and Type	3/8 in. Male Pipe Adapter
Hose Whips	Yes
Weight	
Anti-Vibration Handle Model.....	67 lbs/30 kg
Anti-Vibration Handle w/ Extended Foot Model.....	68 lbs/31 kg
Overall Length – Standard Foot	25.25 in/64 cm
Overall Length – Extended Foot.....	28.75 in/73 cm
Overall Width – Anti-Vibration Handle	16 in/40.6 cm
Maximum Fluid Temperature	140 °F/60 °C
EHTMA Category.....	“C” (20 lpm@ 138 bar) or “D” (30 lpm@ 138 bar)
Noise Level.....	Lwa 106
Vibration Level.....	20.0 m/s ²

ACCESSORIES (SECONDARY FOOT & CUPS)

Special spikes listed below may require the use of a special spike drive foot with changeable cups. Order spike drive foot based on model.

CAUTION

STANLEY recommends that this change be performed by a authorized service center.

Spike Driver Foot (Standard) for screw on cups (Models SD67101, SD67101B)	23342
Spike Driver Foot (Extended) for screw on cups (Models SD67141, SD67141B).....	28206
Dome Head Spike Cup.....	25525
Hairpin Cup.....	23345
Cutspike Cup.....	23344

SPECIAL TOOLS

O-ring Tool Kit.....	04337
Split Rings (Used with 04910)	04908
Spacer	04909
Flow Sleeve Removal Tube (Used with 04908 & 05508)	04910
Accumulator Disassembly Tool (Used with 04910)	05508
Accumulator Cylinder Puller	05640
Accumulator Plug Wrench	29135
Sleeve.....	30939
Collet 7/8 inch.....	30956
Flow Sleeve Kit (See page 16 for parts included in kit).....	74396

SD67 PARTS ILLUSTRATION

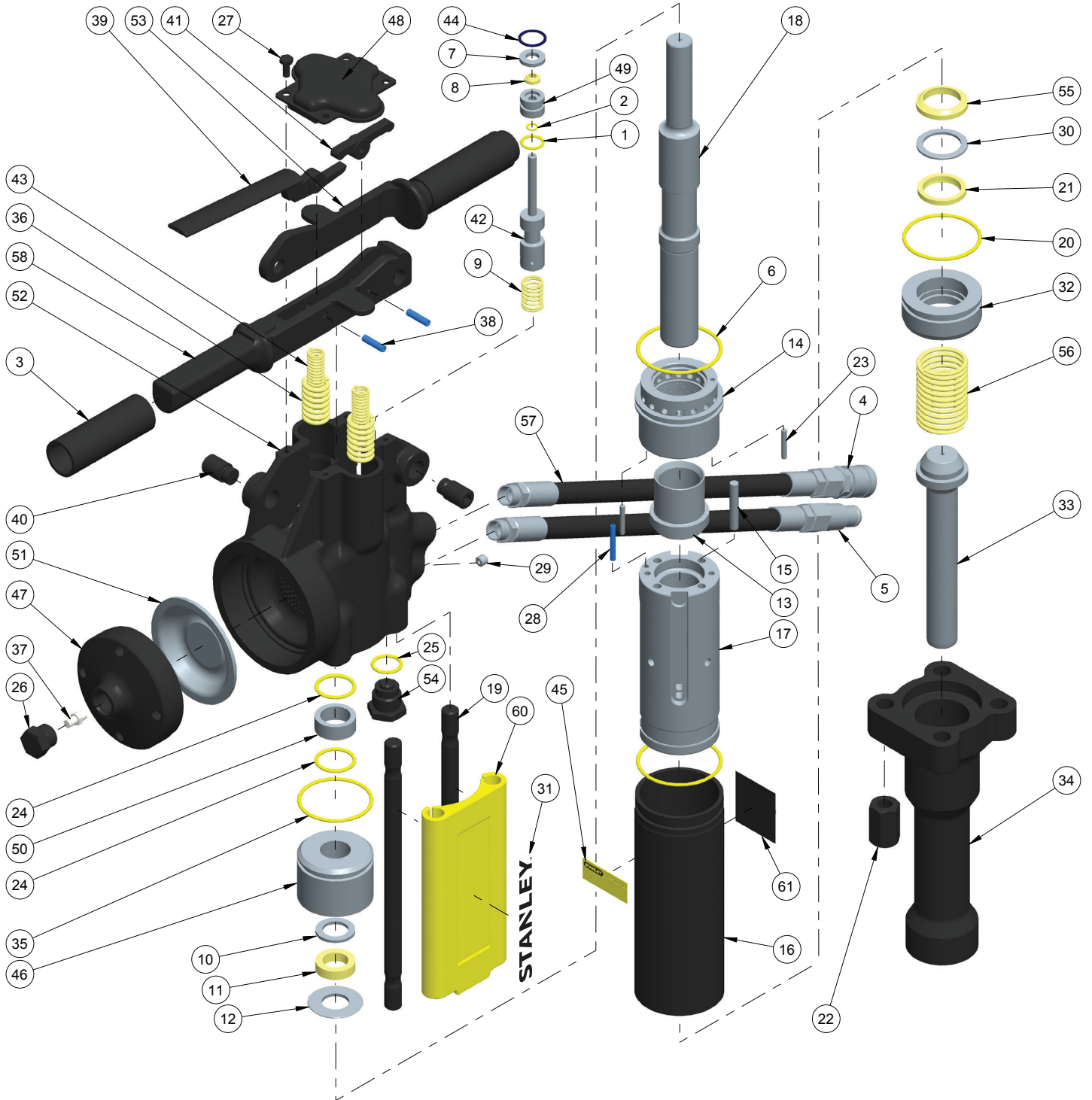

SD67 PARTS LIST

Item	P/N	Qty	Description
1	00293	1	O-RING *
2	01362	1	O-RING *
3	02494	2	HANDLE GRIP
4	03972	1	COUPLER FEMALE(SEE NOTE)
5	03973	1	COUPLER MALE (SEE NOTE)
6	04054	2	O-RING *
7	04055	1	WASHER
8	04056	1	ROD WIPER*
9	04058	1	COMPRESSION COIL SPRING
10	04062	1	BACKUP WASHER
11	04063	1	ROD SEAL *
12	04064	1	SEAL RETAINER WASHER
13	04065	1	AUTOMATIC VALVE
14	04066	1	AUTOMATIC VALVE BODY
15	04067	4	PUSH PIN
16	04068	1	FLOW SLEEVE TUBE
17	04069	1	FLOW SLEEVE (SEE NOTE)
18	04070	1	PISTON
19	04071	4	SIDE ROD
20	04073	1	O-RING*
21	04074	1	ROD WIPER*
22	04075	4	SIDE ROD NUT
23	04571	2	PUSH PIN
24	04795	2	O-RING*
25	06891	1	O-RING*
26	07493	1	O-RING PLUG MALE MODIFIED
27	07628	4	HHCS 1/4-20UNC X .625
28	07890	1	ROLL PIN 3/16 O.D. X 1.500 LG.
29	12832	1	ORIFACE PLUG
30	13837	1	SEAL WASHER
31	74832	2	STANLEY LOGO
32	15419	1	SEAL CARRIER
33	15420	1	RAM (USED WITH SPIKE DRIVER FOOT (73322)
	28207	1	RAM EXTENDED (USED WITH SPIKE DRIVER FOOT 73187)
34	73322	1	SPIKE DRIVER FOOT SOLID (SD67101 & SD67101B ONLY)
	73187	1	SPIKE DRIVER FOOT EXTENDED SOLID (SD67141 &SD67141B ONLY)
35	16732	1	O-RING *

Item	P/N	Qty	Description
36	20498	2	COMPRESSION COIL SPRING
37	20499	1	CHARGE VALVE
38	20500	2	ROLL PIN 1/4 O.D. X 1.000 LG.
39	20502	1	CAST TRIGGER
40	20508	2	PIVOT SCREW
41	20511	1	LEVER
42	20515	1	VALVE SPOOL
43	20541	2	COMPRESSION COIL SPRING
44	24067	1	RETAINING RING
45	73680	1	RAILROAD HELP DESK DECAL
46	26448	1	SPACER
47	26449	1	ACCUMULATOR PLUG
48	26450	1	TOP PLATE
49	26451	1	BUSHING
50	26452	1	SINTERED FILTER
51	26574	1	DIAPHRAGM 4.210 DIA
52	26596	1	ACCUMULATOR VALVE BLOCK
53	28369	1	HANDLE (GUARDED)
54	31067	1	SPACER PLUG
55	34127	1	CUP SEAL
56	44873	1	COMPRESSION COIL SPRING
57	56725	2	HOSE ASSY RAILROAD 18"
58	58529	1	TRIGGER HANDLE
59	66727	2	HOSE ASSY
60	73025	2	FILLER SNAP-ON LARGE
61	74670	1	NAME TAG-SD67
	04596	1	SEAL KIT (INCL PARTS W/*)

NOTE: There is a flow sleeve kit available P/N-74396 that includes: item # 6 (Qty-2 04054 o-ring), item # 15 (qty-4 04067 push pin), item # 17 (qty-1 04069 flow sleeve), item # 20 (qty-1 04073 o-ring) and inst sheet 74398.

NOTE: SEE BELOW FOR COUPLER AND HOSES FOR EACH MODEL.

SD67101 & SD67141 (Couplers 03972 & 03973) Set P/N-03971, Hose Assy P/N-56725

SD67101B & SD67141B (Couplers 81158 & 81159) Set P/N-81160, Hose Assy P/N-66727

MODEL DESCRIPTIONS

SD67101 & SD67101B: Anti-Vibration Handles and Standard (Short) Solid Foot.

SD67141 & SD67141B: Anti-Vibration Handles and Extended (Long) Solid Foot.

STANLEY®

STANLEY Infrastructure
6430 SE Lake Road
Portland, Oregon 97222 USA
(503) 659-5660 / Fax (503) 652-1780
www.stanleyinfrastructure.com